





# Modular Type Filter Regulators Series AW

Filter Regulator Series AW	Model	Port size	Option	
 <p>Page 59 through to 66</p>	AW10	M5 x 0.8		
	AW20	1/8, 1/4		
	AW30	1/4, 3/8		
	AW40	1/4, 3/8, 1/2		
	AW40-06	3/4		
	AW60	3/4, 1		
 <p>Page 59 through to 66</p>	AW20K	1/8, 1/4		
	AW30K	1/4, 3/8		
	AW40K	1/4, 3/8, 1/2		
	AW40K-06	3/4		
	AW60K	3/4, 1		
 <p>Page 67 through to 72</p>	AWM20	1/8, 1/4		Square embedded type pressure gauge (except for the AW10)
	AWM30	1/4, 3/8		Digital pressure switch (except for the AW10)
	AWM40	1/4, 3/8, 1/2		Round type pressure gauge Panel mount
 <p>Page 67 through to 72</p>	AWD20	1/8, 1/4		
	AWD30	1/4, 3/8		
	AWD40	1/4, 3/8, 1/2		

# Filter Regulator

## AW10 to AW60

### Filter Regulator with Backflow Mechanism

## AW20K to AW60K

JIS Symbol  
Filter Regulator

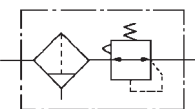

Symbol  
Filter Regulator with  
Backflow Mechanism

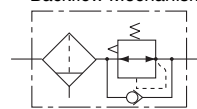

- Integrated filter and regulator units save space and require less piping.
- With the backflow function it incorporates a mechanism to exhaust the air pressure in the outlet side reliably and quickly.

Example)

When the air supply is cut off and releasing the inlet pressure to the atmosphere, the residual pressure release of the outlet side can be ensured for a safety purpose.

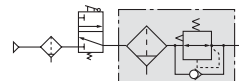

### How to Order

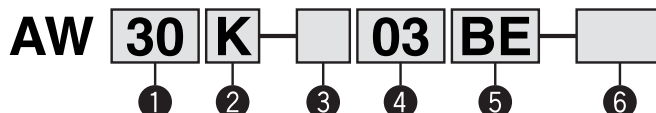

- Option / Semi-standard: Select one each for a to i.
  - Option / Semi-standard symbol: Enter them alphanumerically.
- Example) AW30K-03BE-1N

	Symbol	Description	①					
			Body size					
			10	20	30	40	60	
②	With backflow mechanism	Nil	Without backflow mechanism					
		K <small>Note 1)</small>	With backflow mechanism					
+								
③	Thread type	Nil	Metric thread (M5)					
			Rc					
		N <small>Note 2)</small>	NPT					
		F <small>Note 3)</small>	G					
+								
④	Port size	M5	M5					
		01	1/8					
		02	1/4					
		03	3/8					
		04	1/2					
		06	3/4					
+								
⑤ Option	a	Mounting	Nil	Without mounting option				
			B <small>Note 5)</small>	With bracket				
			H	With set nut (for panel fitting)				
	+							
	b	Float type auto drain	Nil	Without auto drain				
			C	Float type auto drain (N.C.)				
			D	Float type auto drain (N.O.)				
	+							
	c	Pressure gauge	Nil	Without pressure gauge				
			E	Square embedded type pressure gauge (with limit indicator)				
			G	Round type pressure switch (without limit indicator)				
				Round type pressure switch (with limit indicator)				
Digital pressure switch		E1 <small>Note 6)</small>	Output: NPN output / Electrical entry: Wiring bottom entry					
		E2 <small>Note 6)</small>	Output: NPN output / Electrical entry: Wiring top entry					
+								
⑥ Semi-standard	d	Set pressure	Nil	0.05 to 0.85 MPa set				
			1 <small>Note 7)</small>	0.02 to 0.2 MPa set				
	+							
	e	Bowl	Nil	Polycarbonate bowl				
			2	Metal bowl				
			6	Nylon bowl				
			8	Metal bowl with level gauge				
			C	With bowl guard				
			6C	Nylon bowl with bowl guard				

# Filter Regulator *Series AW10 to AW60*

## Filter Regulator with Backflow Mechanism *Series AW20K to AW60K*



AW20/AW20K AW40/AW40K

		Symbol	Description	①					
				Body size					
				10	20	30	40	60	
6	f	Drain port <sup>Note 8)</sup>	Nil	With drain cock	●	●	●	●	●
			J <sup>Note 9)</sup>	Drain guide 1/8	—	●	—	—	—
			W <sup>Note 10)</sup>	Drain guide 1/4	—	—	●	●	●
				Drain cock with barb fitting: For ø6 x ø4 nylon tube	—	—	●	●	●
	+								
	g	Exhaust mechanism	Nil	Relieving type	●	●	●	●	●
			N	Non-relieving type	●	●	●	●	●
	+								
	h	Flow direction	Nil	Flow direction: Left to right	●	●	●	●	●
			R	Flow direction: Right to left	●	●	●	●	●
	+								
	i	Pressure unit	Nil	Name plate, caution plate for bowl, and pressure gauge in imperial units: MPa	●	●	●	●	●
Z <sup>Note 11)</sup>			Name plate, caution plate for bowl, and pressure gauge in imperial units (PSI, F)	○ <sup>Note 13)</sup>	○ <sup>Note 13)</sup>	○ <sup>Note 13)</sup>	○ <sup>Note 13)</sup>	○ <sup>Note 13)</sup>	
ZA <sup>Note 12)</sup>			Digital pressure switch: With unit switching function	—	△ <sup>Note 14)</sup>	△ <sup>Note 14)</sup>	△ <sup>Note 14)</sup>	△ <sup>Note 14)</sup>	

Note 1) The AR10 comes with a backflow mechanism as a standard feature. (K is not available.) When using the AW10 type as w/ backflow mechanism, back flow may not occur with the set pressure 0.15 MPa or less.

Note 2) Drain guide is NPT1/8 (applicable to the AW20(K)) and NPT1/4 (applicable to the AW30(K) to AW60(K)). The exhaust port for auto drain comes with ø3/8" One-touch fitting (applicable to the AW30(K) to AW60(K)).

Note 3) Drain guide is G1/8 (applicable to the AW20) and G1/4 (applicable to the AW30(K) to AW60(K)).

Note 4) Option B, G, and H are not assembled and are

supplied loose at the time of shipment.

Note 5) Assembly of a bracket and set nuts (the AW10, AW20(K) to AW40(K))

Including 2 mounting screws for the AW60(K)  
Note 6) When choosing with H (panel mount), the installation space for lead wires will not be secured. In this case, select "wiring top entry" for the lead wire entry.

Note 7) The only difference from the standard specifications is the adjusting spring for the regulator. It does not restrict the setting of 0.2MPa or more. When the pressure gauge is attached, a 0.2 MPa pressure gauge will be fitted.

Note 8) Float type auto drain: The combination between C and D is not available.

Note 9) Without a valve function

Note 10) Metal bowl: The combination of 2 and 8 cannot be selected.

Note 11) For thread type: M5 and NPT. This product is for overseas use only according to the new Measurement Law. (The SI unit type is provided for use in Japan.) The digital pressure switch will be equipped with the unit switching function, setting to PSI initially.

Note 12) For options: E1, E2, E3, E4. This product is for overseas use only according to the new Measurement Law. (The SI unit is provided for use in Japan.)

Note 13) ○: For thread type: M5 and NPT only

Note 14) △: Combination available for options: E1, E2, E3, E4.

### Standard Specifications

Model	AW10	AW20(K)	AW30(K)	AW40(K)	AW40(K)-06	AW60(K)
Port size	M5 x 0.8	1/8, 1/4	1/4, 3/8	1/4, 3/8, 1/2	3/4	3/4, 1
Pressure gauge port size <sup>Note 1)</sup>	1/16 <sup>Note 2)</sup>	1/8		1/4		
Fluid	Air					
Ambient and fluid temperature <sup>Note 3)</sup>	-5 to 60°C (with no freezing)					
Proof pressure	1.5 MPa					
Maximum operating pressure	1.0 MPa					
Set pressure range	0.05 to 0.7 MPa	0.05 to 0.85 MPa				
Relief pressure	Set pressure + 0.05 MPa <sup>Note 4)</sup> [at relief flow rate of 0.1 l/min (ANR)]					
Nominal filtration rating	5 m					
Drain capacity (cm <sup>3</sup> )	2.5	8	25	45	45	45
Bowl material	Polycarbonate					
Bowl guard	—	Semi-standard	Standard			
Construction	Relieving type					
Weight (kg)	0.09	0.32	0.40	0.72	0.75	2.00

Note 1) Pressure gauge connection threads are not available for F.R.L. unit with a square embedded type pressure gauge (the AW20(K) to AW60(K)).

Note 2) Use a bushing (part no:131368) when connecting the R 1/8 pressure gauge to the R 1/16.

Note 3) -5 to 50C for the products with the digital pressure switch

Note 4) Not applicable to the AW10.

# Series AW10 to AW60

# Series AW20K to AW60K

## Option / Part No.

Option		Model	AW10	AW20(K)	AW30(K)	AW40(K)	AW40(K)-06	AW60(K)	
<b>Bracket assembly</b> <sup>Note 1)</sup>			AR10P-270AS	AW20P-270AS	AR30P-270AS	AR40P-270AS		AW60P-270AS <sup>Note 6)</sup>	
<b>Set nut</b>			AR10P-260S	AR20P-260S	AR30P-260S	AR40P-260S		— <sup>Note 7)</sup>	
<b>Pressure gauge</b>	<b>Round type</b> <sup>Note 2)</sup>	<b>Standard</b>	G27-10-R1	G36-10-□01		G46-10-□02			
		<b>0.02 to 0.2 MPa set</b>	G27-10-R1 <sup>Note 2)</sup>	G36-2-□01		G46-2-□02			
	<b>Square embedded type</b> <sup>Note 4)</sup>	<b>Standard</b>	—	GC3-10AS [GC3P-010AS (Pressure gauge cover only)]					
		<b>0.02 to 0.2 MPa set</b>	—	GC3-2AS [GC3P-010AS (Pressure gauge cover only)]					
<b>Digital pressure switch</b>	<b>NPN output / Wiring bottom entry</b>		—	ISE35-N-25-MLA [ISE35-N-25-M (Switch body only)]					
	<b>NPN output / Wiring top entry</b>			ISE35-R-25-MLA [ISE35-R-25-M (Switch body only)]					
	<b>PNP output / Wiring bottom entry</b>			ISE35-N-65-MLA [ISE35-N-65-M (Switch body only)]					
	<b>PNP output / Wiring top entry</b>			ISE35-R-65-MLA [ISE35-R-65-M (Switch body only)]					
<b>Float type auto drain</b> <sup>Note 8)</sup>		<b>N.O.</b>	—	—	AD38	AD48			
		<b>N.C.</b>	AD17	AD27	AD37	AD47			

Note 1) Assembly of a bracket and set nuts

Note 2) □ in part numbers for a round pressure gauge indicates a type of connection thread. No indication is necessary for R; however, indicate N for NPT. Please contact SMC regarding the connection thread NPT and pressure gauge supply for PSI unit specifications.

Note 3) Standard pressure gauge

Note 4) Including one O-ring and 2 mounting screws. [ ]: Pressure gauge cover only

Note 5) Lead wire with connector (2 m), adaptor, lock pin, O-ring (1 pc.), mounting screw (2 pcs.) are attached. [ ]: Switch body only. Also, regarding how to order the digital pressure switch, please refer to page 73. A pressure switch adaptor assembly (AW60P-310AS) will be additionally required for the AW60(K) only. Use the attached mounting screw (M3 x 0.5 x 14) for mounting. The mounting screw (M3 x 0.5 x 7) attached to the digital pressure switch assembly will not be required.

Note 6) Assembly of a bracket and 2 mounting screws

Note 7) Please consult with SMC regarding the set nuts for the AW60(K).

Note 8) Minimum operating pressure: N.O. type—0.1 MPa; N.C. type—0.1 MPa (AD27) and 0.15 MPa (AD37/47). Please contact SMC for PSI and F specifications.



## Specific Product Precautions

**Be sure to read this before handling. Refer to “Precautions for Handling Pneumatic Devices” (M-03-E3A) for Safety Instructions and F.R.L. Unit Precautions.**

### Selection

#### Warning

- Residual pressure disposal (outlet pressure removal) is not possible for the AW20 to AW60 even though the inlet pressure is exhausted. When the residual pressure disposal is performed, use the regulator with backflow mechanism (the AW20K to AW60K).

### Maintenance

#### Warning

- Replace the element every 2 years or when the pressure drop becomes 0.1 MPa, whichever comes first, to prevent damage to the element.

### Mounting and Adjustment

#### Warning

- Set the regulator while verifying the displayed values of the inlet and outlet pressure gauges. Turning the regulator knob excessively can cause damage to the internal parts.
- The pressure gauge included with regulators for 0.02 to 0.2 MPa setting is for up to 0.2 MPa use only (except for the AR10). Exceeding 0.2 MPa of pressure can damage the gauge.
- Do not use tools on the pressure regulator knob as this may cause damage. It must be operated manually.

#### Caution

- Be sure to unlock the knob before adjusting the pressure and lock it after setting the pressure. Failure to follow this procedure can cause damage to the knob and the outlet pressure may fluctuate.
  - Pull the pressure regulator knob to unlock. (You can visually verify this with the “orange mark” that appears in the gap.)
  - Push the pressure regulator knob to lock. When the knob is not easily locked, turn it left and right a little and then push it (when the knob is locked, the “orange mark”, i.e., the gap will disappear).
- A knob cover is available to prevent careless operation of the knob. Refer to “Features 1” for details.



## Flow Characteristics (Representative values)

Condition Inlet pressure 0.7 MPa

**AW10** M5

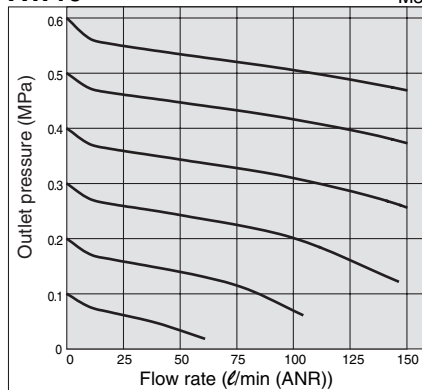

**AW30(K)** Rc 3/8

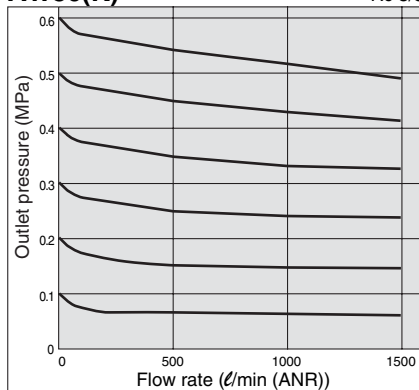

**AW40(K)-06** Rc 3/4

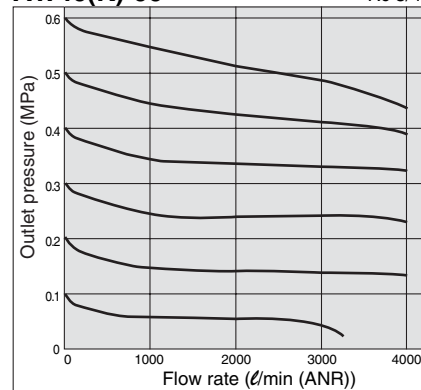

**AW20(K)** Rc 1/4

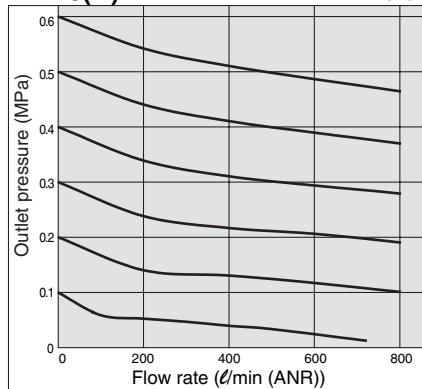

**AW40(K)** Rc 1/2

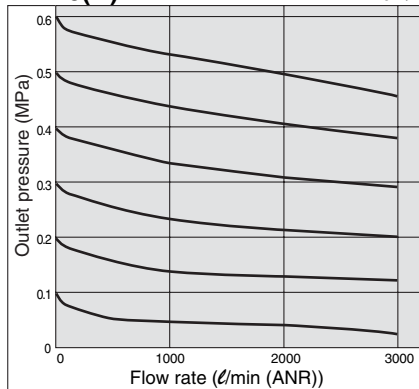

**AW60(K)** Rc 3/2

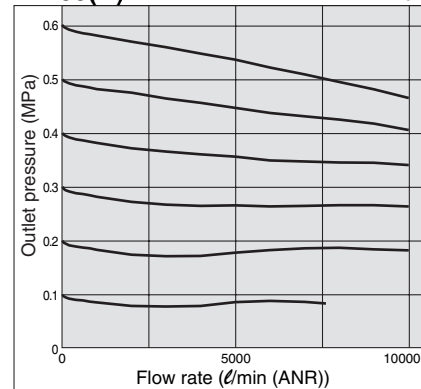

## Pressure Characteristics (Representative values)

Conditions Inlet pressure 0.7 MPa, Outlet pressure 0.2 MPa, Flow rate 20 ℓ/min (ANR)

**AW10**

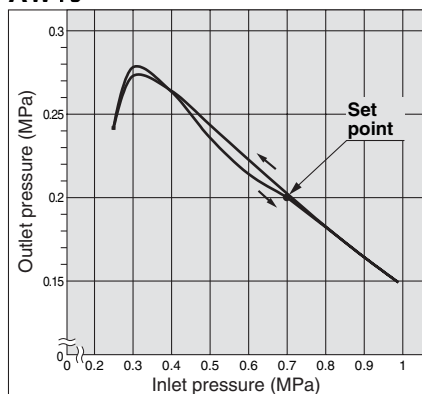

**AW30(K)**

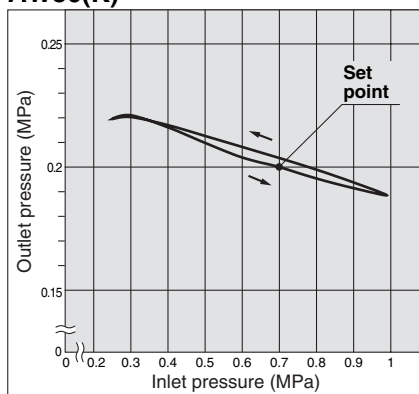

**AW40(K)-06**

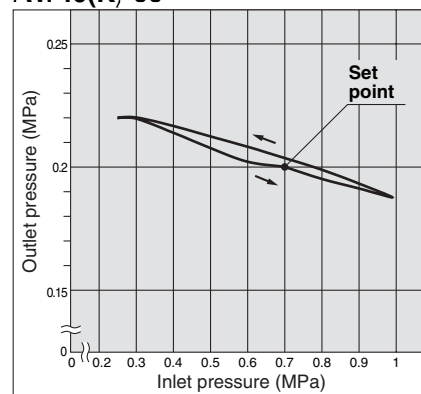

**AW20(K)**

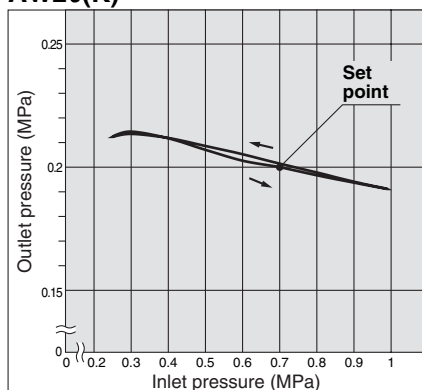

**AW40(K)**

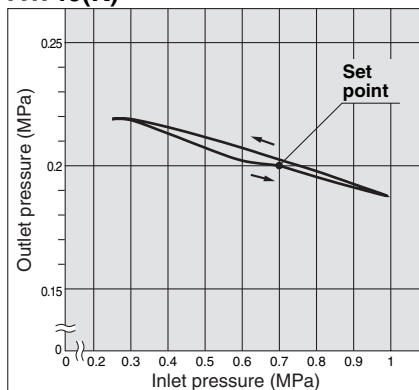

**AW60(K)**

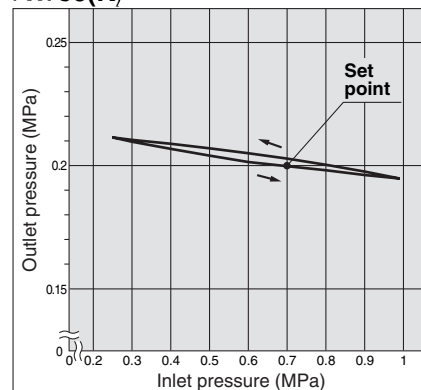

# Series AW10 to AW60

## Series AW20K to AW60K

### Construction

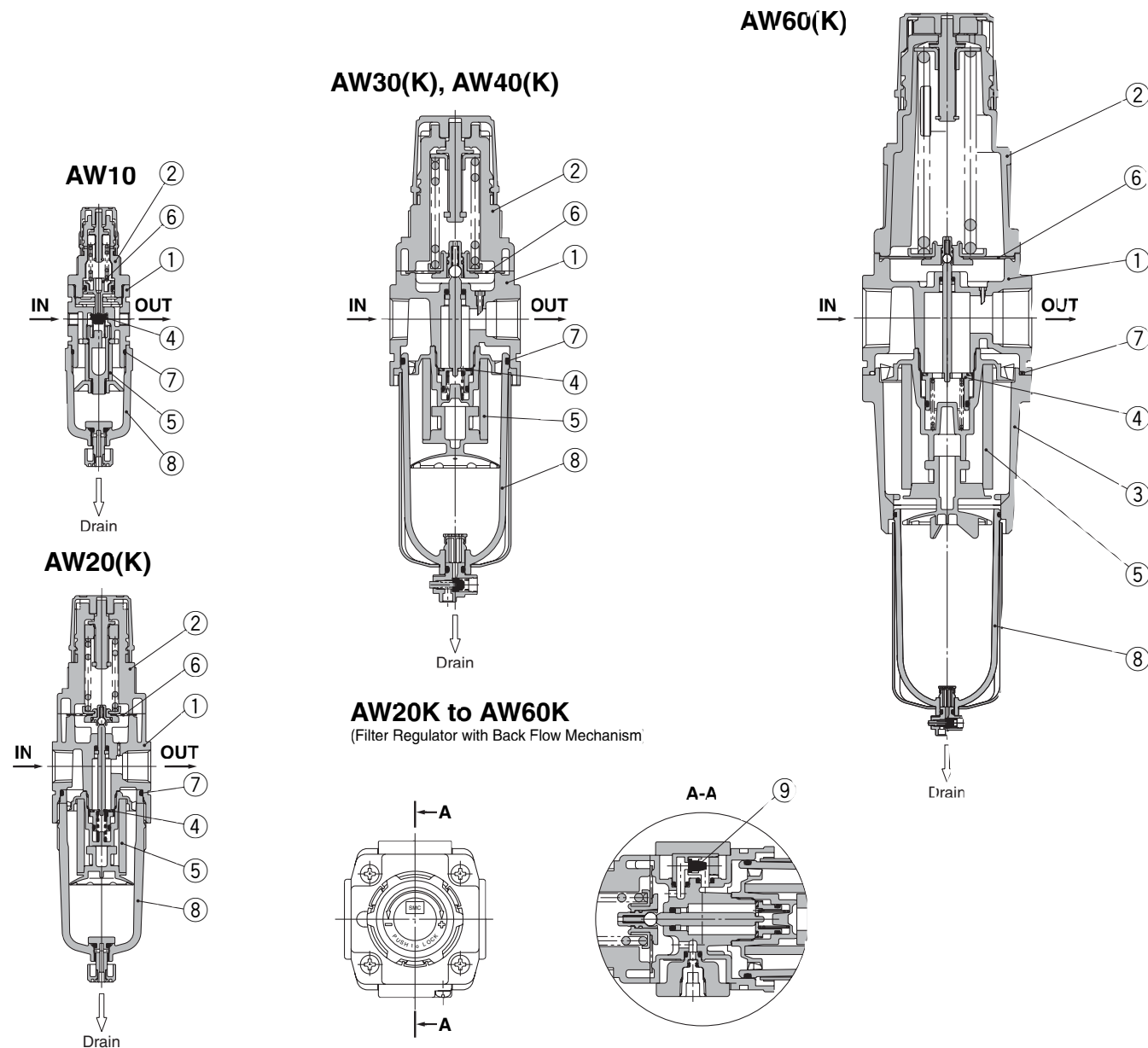

### Component Parts

No.	Description	Material	Model	Note
1	Body	Zinc die-cast	AW10, AW20	Platinur silver
		Aluminum die-cast	AW30 to AW60	
2	Bonnet	Polyacetal	AW10 to AW40	Black
		Aluminum die-cast	AW60	
3	Housing	Aluminum die-cast	AW60	Platinur silver

### Replacement Parts

No.	Description	Material	Part no.				
			AR10	AW20(K)	AW30(K)	AW40(K)	AR40(K)-60
4	Valve assembly	Brass, HNBR	AR10P-090S	AW20P-340AS	AW30P-340AS	AW40P-340AS	AW60P-090AS
5	Filter element	Non-woven fabric	AF10P-060S	AF20P-060S	AF30P-060S	AF40P-060S	AW60P-060S
6	Diaphragm assembly	Weatherable NBR	AR10P-150AS <sup>Note 1)</sup>	AR20P-150AS	AR30P-150AS	AR40P-150AS	AR50P-150AS
7	Bowl O-ring	NBR	C1SFP-260S	C2SFP-260S	C3SFP-260S	C4SFP-260S	
8	Bowl assembly <sup>Note 2)</sup>	Polycarbonate	C1SF	C2SF	C3SF <sup>Note 3)</sup>	C4SF <sup>Note 3)</sup>	
9	Check valve assembly <sup>Note 4)</sup>	—	—	—	AR20KF-020AS		

Note 1) The AW10 is a piston type. Assembly of a piston and a seal (KSY-P-13).

Note 2) Including O-ring. Please contact SMC regarding the bowl assembly supply for PSI and F unit specifications

Note 3) Bowl assembly for the AW30(K) to AW60(K) comes with a bowl guard (steel band material)

Note 4) Check valve assembly is applicable for a filter regulator with backflow mechanism (the AW20K to AW60K only).

Assembly of a check valve cover, check valve body assembly and 2 screws

## Working Principle (Filter Regulator with Backflow Mechanism)

### AW10



When the inlet pressure is higher than the regulating pressure, the check valve operates as a normal regulator (Figure 1).

When the inlet pressure is shut off and exhausted, any inlet pressure applied to the valve ① will be lost. The force for seating the valve ① is the valve spring force ② only. When the valve ① is opened using the outlet force, the outlet pressure will be exhausted at the inlet side (Figure 2).

When the set pressure is 0.15 MPa or less, valve ① may not open due to the valve spring ② force.

### AW20K to AW60K

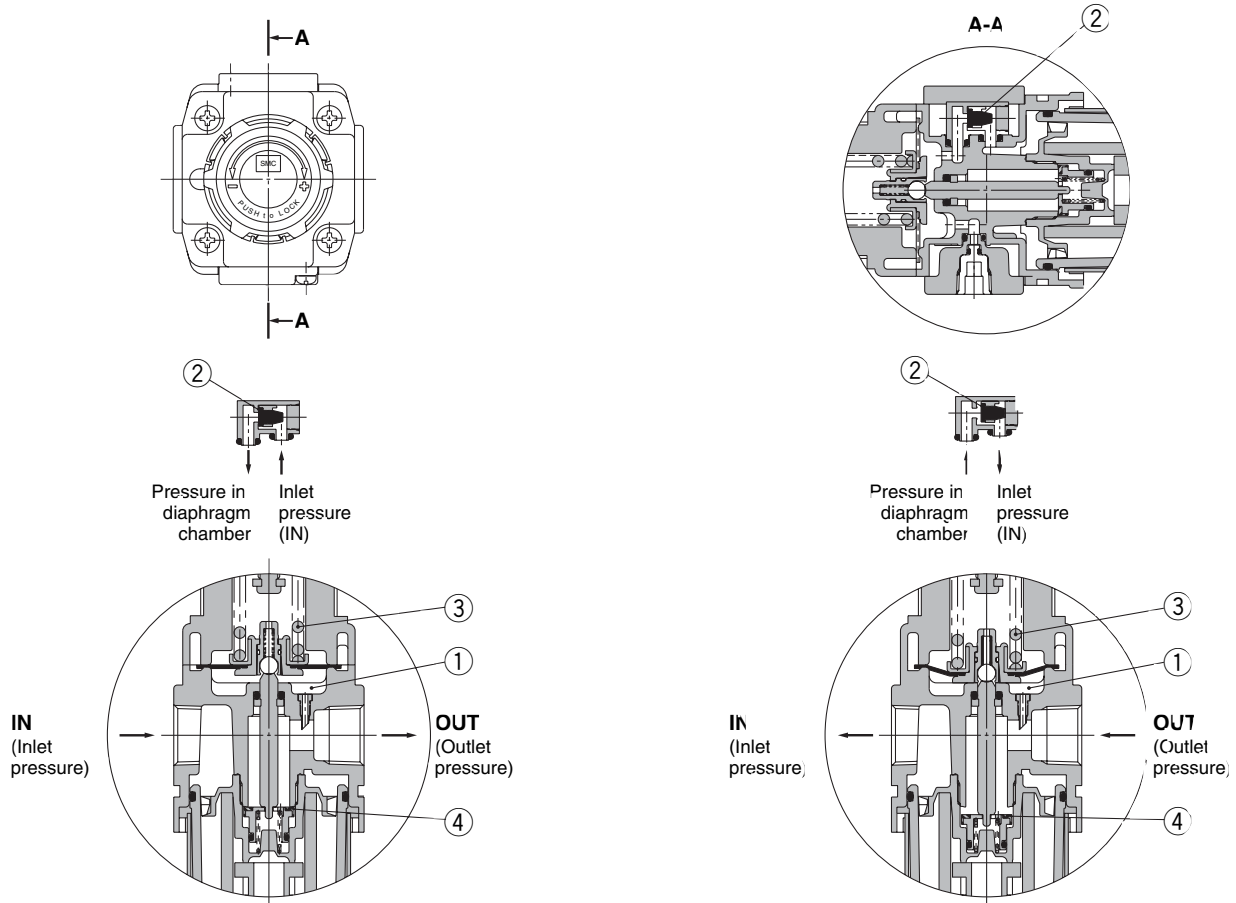

Figure 1 Normal

Figure 2 Back flow

When the inlet pressure is higher than the regulating pressure, the check valve ② closes and operates as a normal regulator (Figure 1). When the inlet pressure is shut off and released, the check valve ② opens and the pressure in the diaphragm chamber ① is released into the inlet side (Figure 2).

This lowers the pressure in the diaphragm chamber ① and the force generated by the pressure regulator spring ③ lifts the diaphragm. Valve ④ opens through the stem, and the outlet pressure is released to the inlet side (Figure 2).



# Series AW10 to AW60

## Series AW20K to AW60K

### Dimensions

#### AW10, AW20(K)

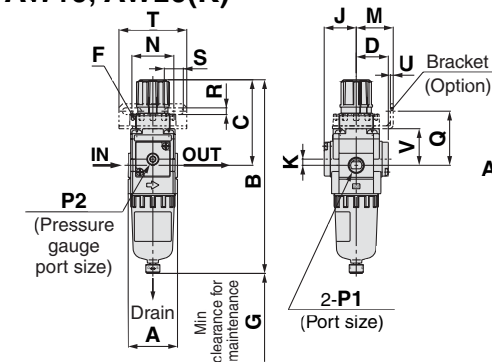

Panel fitting dimension

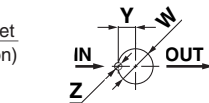

AW10, AW20(K): Max. 3.5

#### AW60(K)

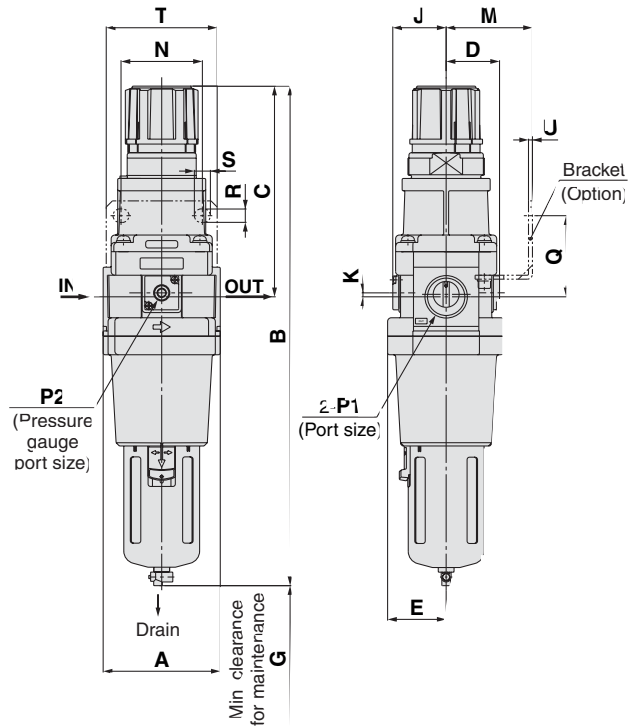

#### AW30(K) to AW40(K)-06

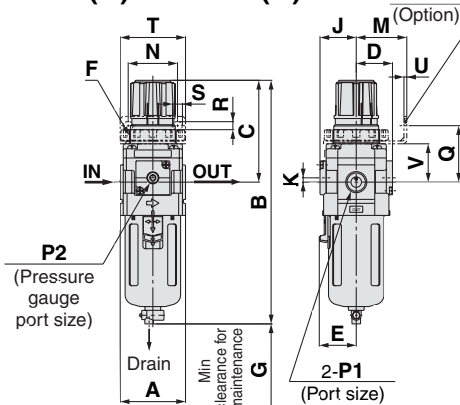

Panel fitting dimension

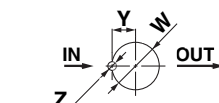

AW30(K) Max. 3.5  
AW40(K): Max. 5

Applicable model	AW20(K) to AW60(K)		AW10, AW20(K) to AW60(K)
Option	Square embedded type pressure gauge	Digital pressure switch	Round type pressure gauge
Dimensions			

Applicable model	AW10, AW20(K)		AW20(K)	AW30(K) to AW60(K)				
	Optional/Semi-standard specifications	With auto drain (N.C.)	Metal bowl	With drain guide	With auto drain (N.O./N.C.)	Metal bowl	Metal bowl with level gauge	With drain guide
Dimensions								
			Width across flats 14				Width across flats 17	

Model	Standard specifications												Optional specifications				
	P1	P2	A	B (Note)	C	D	E	F	G	J	K	H	J	H	J	H	J
AW10	M5 x 0.8	1/16	25	108	48	12.5	—	M18 x 1	25	13	0	—	—	—	—	ø26	26
AW20(K)	1/8, 1/4	1/8	40	160	73	26	—	M28 x 1	40	26	5	□28	27	□27.8	37.5	ø37.5	63
AW30(K)	1/4, 3/8	1/8	53	201	86	29.5	30	M38 x 1.5	55	29.5	3.5	□28	30.5	□27.8	41	ø37.5	66
AW40(K)	1/4, 3/8, 1/2	1/4	70	239	92	37.5	38	M42 x 1.5	80	37.5	1.5	□28	38.5	□27.8	49	ø42.5	76
AW40(K)-06	3/4	1/4	75	242	93	37.5	38	M42 x 1.5	80	37.5	1.2	□28	38.5	□27.8	49	ø42.5	76
AW60(K)	3/4, 1	1/4	95	409	175	43.5	47.5	—	20	43.5	3.2	□28	44.5	□27.8	61.5	ø42.5	84

Model	Optional specifications											Semi-standard specifications				
	Bracket mount					Panel mount						With auto drain	With barb fitting	With drain guide	Metal bowl	Metal bowl with level gauge
	M	N	Q	R	S	T	U	V	W	Y	Z	B	B	B	B	B
AW10	25	28	30	4.5	6.5	40	2	18	18.5	—	—	125	—	—	107	—
AW20(K)	30	34	44	5.4	15.4	55	2.3	30	28.5	14	6	177	—	164	160	—
AW30(K)	41	40	46	6.5	8	53	2.3	31	38.5	19	7	242	209	208	214	234
AW40(K)	50	54	54	8.5	10.5	70	2.3	35.5	42.5	21	7	278	247	246	252	272
AW40(K)-06	50	54	56	8.5	10.5	70	2.3	37	42.5	21	7	282	251	249	255	275
AW60(K)	70	66	66	11	13	90	3.2	—	—	—	—	448	417	416	422	442

Note) The total length of B dimension is the length when the filter regulator handle is unlocked.



# Filter Regulator AW20 to AW60 Made to Order



Please contact SMC for detailed dimensions, specifications, and lead times.



AW30-03-2-X425

## ① Special Temperature Environment

Special materials are used in the manufacturing of seals and resin parts to allow them to withstand various temperature conditions in cold or tropical (hot) climates.

### Specifications

Made-to-order part no.	-X430	-X440
Environment	Low temperature	High temperature
Ambient temperature (°C)	-30 to 60°C	-5 to 80°C
Fluid temperature (°C)	-5 to 60°C (with no freezing)	
Material	Rubber parts	Special NBR
	Main parts	FKM
	Metal (Aluminum die-cast), etc.	

### Applicable Model

Model	AW30	AW40	AW40-06	AW60
Port size	1/4, 3/8	1/4, 3/8, 1/2	3/4	3/4, 1

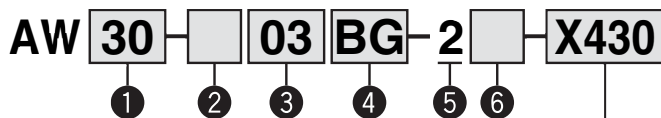

- Option / Semi-standard: Select one each for a to g.
  - Option / Semi-standard symbol: Enter them alphanumerically.
- Example) AW30-03BG-2N-X430

For high/low temperature

X430	Low temperature
X440	High temperature

	Symbol	Description	① Body size			
			30	40	60	
② Thread type	Nil	Rc	●	●	●	
	N	NPT	●	●	●	
	F	G	●	●	●	
+						
③ Port size	02	1/4	●	●	—	
	03	3/8	●	●	—	
	04	1/2	—	●	—	
	06	3/4	—	●	●	
	10	1	—	—	●	
+						
④ Option	a Mounting	Nil Without mounting option	●	●	●	
	B Note 2	With bracket	●	●	●	
	H	With set nut (for panel fitting)	●	●	—	
+						
b Pressure gauge	Nil	Without pressure gauge	●	●	●	
	G	Round type pressure switch (without limit indicator)	●	●	●	
+						
⑤ Bowl Note 3	2	Metal bowl	●	●	●	
+						
⑥ Semi-standard	c Set pressure	1 Note 4	0.05 to 0.85 MPa set	●	●	●
		1	0.02 to 0.2 MPa set	●	●	●
	+					
	d Drain port	Nil	With drain cock	●	●	●
		J Note 5	Drain guide 1/4	●	●	●
	+					
	e Exhaust mechanism	Nil	Relieving type	●	●	●
		N	Non-relieving type	●	●	●
	+					
	f Flow direction	Nil	Flow direction: Left to right	●	●	●
R		Flow direction: Right to left	●	●	●	
+						
g Pressure unit	Nil	Name plate, caution plate for bowl, and pressure gauge in imperial units: MPa	●	●	●	
	Z Note 6	Name plate, caution plate for bowl, and pressure gauge in imperial units (PSI, F)	○	○	○	

- Note 1) Option B, G and H are not assembled and are supplied loose at the time of shipment.  
 Note 2) Assembly of a bracket and set nuts (the AW30 to AW40)  
 Including 2 mounting screws for the AW60  
 Note 3) Only metal bowl 2 is available.  
 Note 4) The only difference from the standard specifications is the adjusting spring for the regulator. It does not restrict the setting of 0.2 MPa or more. When the pressure gauge is attached, a 0.2 MPa pressure gauge will be fitted.  
 Note 5) Without a valve function.  
 Note 6) For thread type: NPT. This product is for overseas use only according to the new Measurement Law. (The SI unit type is provided for use in Japan.)  
 Note 7) ○: For thread type: NPT only

## ② High Pressure

Strong materials are used in the manufacturing of air filters intended for high pressure operation. Also construction modification allows a wider regulating pressure range.

### Specifications

Made-to-order part no.	-X425
Proof pressure (MPa)	3.0
Maximum operating pressure (MPa)	2.0
Set pressure range (MPa)	0.1 to 1.6
Ambient and fluid temperature (°C)	-5 to 60°C (with no freezing)

### Applicable Model

Model	AW20	AW30	AW40	AW40-06	AW60
Port size	1/8, 1/4	1/4, 3/8	1/4, 3/8, 1/2	3/4	3/4, 1

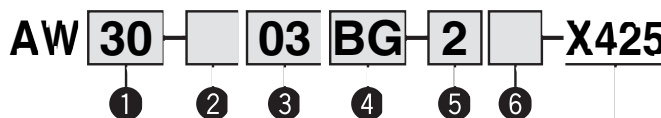

- Option / Semi-standard: Select one each for a to f.
  - Option / Semi-standard symbol: Enter them alphanumerically.
- Example) AW30-03BG-2N-X425

	Symbol	Description	① Body size				
			20	30	40	60	
② Thread type	Nil	Rc	●	●	●	●	
	N	NPT	●	●	●	●	
	F	G	●	●	●	●	
+							
③ Port size	01	1/8	●	—	—	—	
	02	1/4	●	●	—	—	
	03	3/8	—	●	—	—	
	04	1/2	—	—	●	—	
	06	3/4	—	—	●	●	
	10	1	—	—	—	●	
+							
④ Option	a Mounting	Nil Without mounting option	●	●	●	●	
	B Note 2	With bracket	●	●	●	●	
	H	With set nut (for panel fitting)	●	●	—	—	
+							
b Pressure gauge	Nil	Without pressure gauge	●	●	●	●	
	G	Round type pressure switch (with limit indicator)	●	●	●	●	
+							
⑤ Bowl Note 3	2	Metal bowl	●	●	●	●	
	8	Metal bowl with level gauge	—	●	●	●	
+							
⑥ Semi-standard	c Exhaust mechanism	Nil	Relieving type	●	●	●	●
		N	Non-relieving type	●	●	●	●
	+						
	d Drain port	Nil	With drain cock	●	●	●	●
		J Note 4	Drain guide 1/8 Drain guide 1/4	—	●	●	●
	+						
	e Flow direction	Nil	Flow direction: Left to right	●	●	●	●
		R	Flow direction: Right to left	●	●	●	●
	+						
	f Pressure unit	Nil	Name plate, caution plate for bowl, and pressure gauge in imperial units: MPa	●	●	●	●
Z Note 5		Name plate, caution plate for bowl, and pressure gauge in imperial units (PSI, F)	○	○	○	○	

- Note 1) Option B, G and H are not assembled and are supplied loose at the time of shipment.  
 Note 2) Assembly of a bracket and set nuts (the AW20 to AW40)  
 Including 2 mounting screws for the AW60  
 Note 3) Only metal bowl 2 and 8 are available.  
 Note 4) Without a valve function.  
 Note 5) For thread type: NPT. This product is for overseas use only according to the new Measurement Law. (The SI unit type is provided for use in Japan.)  
 Note 6) ○: For thread type: NPT only

# Options

# Digital Pressure Switch

ISE35 — **N** — **25** — **M** **L** **A**

① ② ③ ④ ⑤

	Symbol	Description
① Lead wire entry	N	Wiring bottom entry
	R	Wiring top entry
② Output	25	NPN output
	65	PNP output
③ Display unit (Note 1)	Nil (Note 2)	With unit switching function
	M	Fixed SI unit
	P (Note 2)	Pressure unit: PSI (initial value) with unit display switching function
④ Lead wire	Nil	Without lead wire
	L	Lead wire with connector
⑤ Lead wire entry	Nil	Without accessories (switch body only)
	A	With accessories (adaptor, O-ring (1 pc.), mounting screw (2 pcs.), lock pin)

Note 1) This product is for overseas use only according to the new Measurement Law.  
 Note 2) Unit name plate is attached.  
 Note 3) Instruction manual is attached.  
 Note 4) When ordering the body only, select the symbol from ① to ⑤ respectively.

## Applicable Series

F.R.L. unit	AC20, AC25, AC30, AC40, AC50, AC55, AC60 AC20A, AC30A, AC40A, AC50A, AC60A AC20B, AC25B, AC30B, AC40A, AC50A, AC55B, AC60B AC20C, AC25C, V30C, AC40C AC20D, AC30D, V40D
Regulator	AR20, AR25, AR30, AR40, AR50, AR60
Filter regulator	AW20, AW30, AW40, AW60
Mist separator regulator	AWM20, AWM30, AWM40
Micro mist separator regulator	AWD20, AWD30, AWD40

## Digital Pressure Switch Details

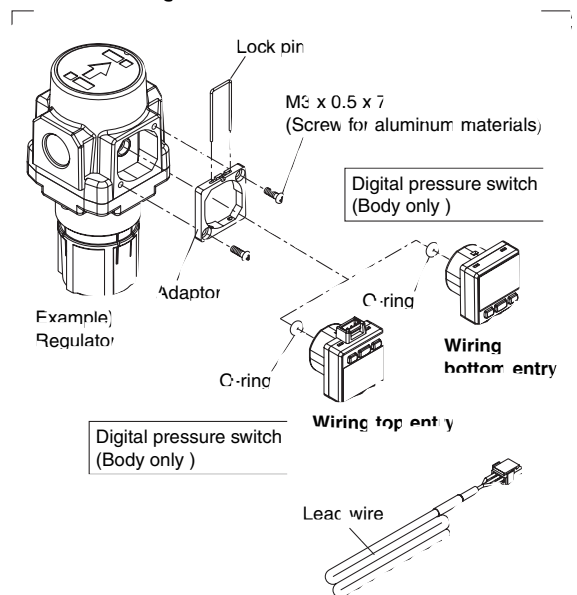

## Specifications

Rated pressure range	0 to 1 MPa	
Set pressure range	-0.1 to 1 MPa	
Withstand pressure	1.5 MPa	
Set pressure resolution	0.01 MPa	
Power supply voltage	12 to 24 VDC, Ripple (p-p) 10% or less (with power supply polarity protection)	
Current consumption	55 mA or less (at no load)	
Switch output	NPN or PNP open collector 1 output	
Max. load current	80 mA	
Max. applied voltage	30 V (with NPN output)	
Residual voltage	1 V or less (with load current of 80 mA)	
Response time	1 s	
Anti-chatter function	(Response time selections: 0.25, 0.5, 2, 3)	
Short circuit protection	With short circuit protection	
Repeatability	1%F.S. or less	
Hysteresis	Hysteresis mode	Variable (can be set from 0)
	Window comparator mode	
Display	3-digit, 7-segment indicator, 2-color display (Red/Green) can be interlocked with the switch output.	
Display accuracy	2%F.S. 1 digit (at 25°C ±3°C)	
Indication light	Illuminates when output is turned ON. (Green)	
Environmental resistance	Enclosure	IP40
Lead wire with connector		ø3.4 3-wire 25AWG 2 m

## Output

### NPN open collector

Max 30 V, 80 mA  
 Residual output voltage V or less

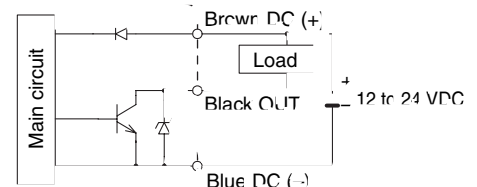

### PNP open collector

Max 30 mA  
 Residual output voltage V or less

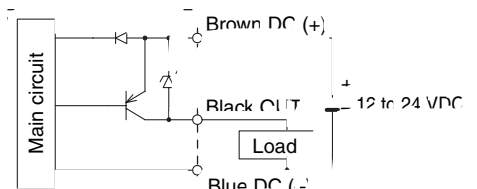





## Series AC

# Safety Instructions

These safety instructions are intended to prevent a hazardous situation and/or equipment damage. These instructions indicate the level of potential hazard by labels of "Caution", "Warning" or "Danger". To ensure safety, be sure to observe ISO 4414 <sup>Note 1)</sup>, JIS B 8370 <sup>Note 2)</sup> and other safety practices.

### ■Explanation of the Labels

Labels	Explanation of the labels
 <b>Danger</b>	In extreme conditions, there is a possible result of serious injury or loss of life.
 <b>Warning</b>	Operator error could result in serious injury or loss of life.
 <b>Caution</b>	Operator error could result in injury <sup>Note 3)</sup> or equipment damage. <sup>Note 4)</sup>

Note 1) ISO 4414: Pneumatic fluid power – General rules relating to systems

Note 2) JIS B 8370: General Rules for Pneumatic Equipment

Note 3) Injury indicates light wounds, burns and electrical shocks that do not require hospitalization or hospital visits for long-term medical treatment.

Note 4) Equipment damage refers to extensive damage to the equipment and surrounding devices.

### ■Selection/Handling/Applications

#### 1. The compatibility of the pneumatic equipment is the responsibility of the person who designs the pneumatic system or decides its specifications.

Since the products specified here are used in various operating conditions, their compatibility for the specific pneumatic system must be based on specifications or post analysis and/or tests to meet the specific requirements. The expected performance and safety assurance are the responsibility of the person who has determined the compatibility of the system. This person should continuously review the suitability of all items specified, referring to the latest catalog information with a view to giving due consideration to any possibility of equipment failure when configuring a system.

#### 2. Only trained personnel should operate pneumatic machinery and equipment.

Compressed air can be dangerous if handled incorrectly. Assembly, handling or repair of the systems using pneumatic equipment should be performed by trained and experienced operators. (Understanding JIS B 8370 General Rules for Pneumatic Equipment, and other safety rules are included.)

#### 3. Do not service the machinery/equipment or attempt to remove components until safety is confirmed.

1. Inspection and maintenance of the machinery/equipment should only be performed once measures to prevent falling or runaway of the driven objects have been confirmed.
2. If the equipment must be removed, confirm the safety process as mentioned above. Turn off the supply pressure for the equipment and exhaust all residual compressed air in the system, and release all the energy (liquid pressure, spring, condenser, gravity).
3. Before the machinery/equipment is restarted, take measures to prevent quick extension of a cylinder piston rod, etc.

#### 4. If the equipment will be used in the following conditions or environment, please contact SMC first and be sure to take all necessary safety precautions.

1. Conditions and environments beyond the given specifications, or if product is used outdoors.
2. Installation on equipment in conjunction with atomic energy, railway, air navigation, vehicles, medical equipment, food and beverages, recreation equipment, emergency stop circuits, clutch and brake circuits in press applications, or safety equipment.
3. An application which has the possibility of having negative effects on people, property, requiring special safety analysis.
4. If the products are used in an interlock circuit, prepare a double interlock style circuit with a mechanical protection function for the prevention of a breakdown. And, examine the devices periodically if they function normally or not.

### ■Exemption from Liability

1. SMC, its officers and employees shall be exempted from liability for any loss or damage arising out of earthquakes or fire, action by a third person, accidents, customer error with or without intention, product misuse, and any other damages caused by abnormal operating conditions.

2. SMC, its officers and employees shall be exempted from liability for any direct or indirect loss or damage, including consequential loss or damage, loss of profits, or loss of chance, claims, demands, proceedings, costs, expenses, awards, judgments and any other liability whatsoever including legal costs and expenses, which may be suffered or incurred, whether in tort (including negligence), contract, breach of statutory duty, equity or otherwise.

3. SMC is exempted from liability for any damages caused by operations not contained in the catalogs and/or instruction manuals, and operations outside of the specification range.

4. SMC is exempted from liability for any loss or damage whatsoever caused by malfunctions of its products when combined with other devices or software.



# SMC'S GLOBAL MANUFACTURING, DISTRIBUTION AND SERVICE NETWORK

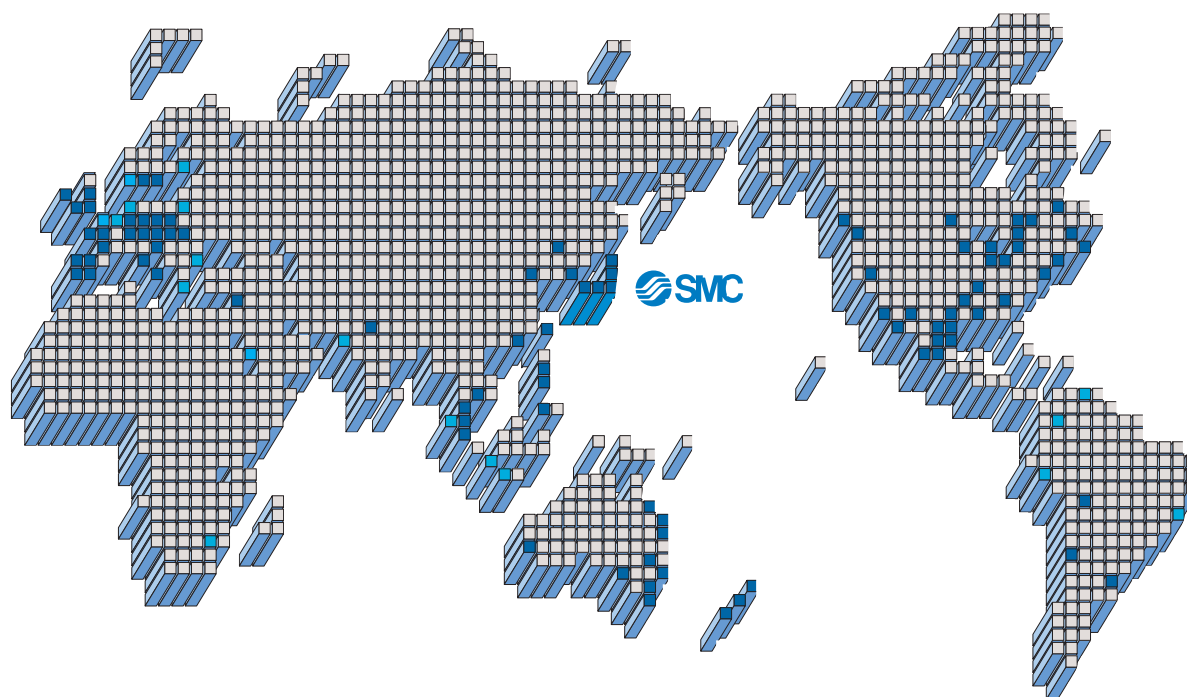

## EUROPE

### AUSTRIA

SMC Pneumatik GmbH

### BELGIUM

SMC Pneumatics N.V./S.A.

### BULGARIA

SMC Industrial Automation Bulgaria EOOD

### CROATIA

SMC Industrijska automatika d.o.o.

### CZECH REPUBLIC

SMC Industrial Automation CZ s.r.o.

### DENMARK

SMC Pneumatik A/S

### ESTONIA

SMC Pneumatics Estonia OÜ

### FINLAND

SMC Pneumatics Finland OY

### FRANCE

SMC Pneumatique SA

### GERMANY

SMC Pneumatik GmbH

### HUNGARY

SMC Hungary Ipari Automatizálási Kft.

### IRELAND

SMC Pneumatics (Ireland) Ltd.

### ITALY

SMC Italia S.p.A.

### LATVIA

SMC Pneumatics Latvia SIA

### LITHUANIA

SMC Pneumatics Lietuva, UAB

### NETHERLANDS

SMC Pneumatics BV

## NORWAY

SMC Pneumatics Norway A/S

## POLAND

SMC Industrial Automation Polska Sp.z.c.o

## ROMANIA

SMC Romania s.r.l.

## RUSSIA

SMC Pneumatik LLC.

## SLOVAKIA

SMC Priemyselna automatizacia s.r.o

## SLOVENIA

SMC INDUSTRIJSKA AVTOMATIKA d.o.o

## SPAIN/PORTUGAL

SMC España, S.A.

## SWEDEN

SMC Pneumatics Sweder AB

## SWITZERLAND

SMC Pneumatik AG

## UK

SMC Pneumatics (U.K.) Ltd.

## ASIA

### CHINA

SMC (China) Co., Ltd.

### HONG KONG

SMC Pneumatics (Hong Kong) Ltd

### INDIA

SMC Pneumatics (India) Pvt. Ltd.

### INDONESIA

PT SMC Pneumatics Indonesia

### MALAYSIA

SMC Pneumatics (S.E.A.) Sdn. Bhd.

### PHILIPPINES

SHOKETSU-SMC Corporation

## SINGAPORE

SMC Pneumatics (S.E.A.) Pte. Ltd.

## SOUTH KOREA

SMC Pneumatics Korea Co., Ltd.

## TAIWAN

SMC Pneumatics (Taiwan) Co., Ltd.

## THAILAND

SMC Thailand Ltd

## NORTH AMERICA

### CANADA

SMC Pneumatics (Canada) Ltd.

### MEXICO

SMC Corporation (Mexico) S.A. de C.V.

### USA

SMC Corporation of America

## SOUTH AMERICA

### ARGENTINA

SMC Argentina S.A

### BOLIVIA

SMC Pneumatics Bolivia S.R.L.

### BRAZIL

SMC Pneumaticos Do Brazil Ltda.

### CHILE

SMC Pneumatics (Chile) S.A.

### VENEZUELA

SMC Neumatica Venezuela S.A

## OCEANIA

### AUSTRALIA

SMC Pneumatics (Australia) Pty. Ltd.

### NEW ZEALAND

SMC Pneumatics (N.Z.) Ltd.



### Safety Instructions

Be sure to read "Precautions for Handling Pneumatic Devices" (M-03-E3A) before using.

## SMC Corporation

Akihabara UDX 15F,  
4-14-1, Sotokanda, Chiyoda-ku, Tokyo 101-0021, JAPAN  
Phone: 03-5207-8249 FAX: 03-5298-5362  
URL <http://www.smcworld.com>  
© 2006 SMC Corporation All Rights Reserved

Specifications are subject to change without prior notice  
and any obligation on the part of the manufacturer.

D-DN

1st printing JX printing KR 120DN Printed in Japan.

This catalog is printed on recycled paper with concern for the global environment.